

ERIKS Oil Seals

sealing technology



ERIKS

Easy accessible dia direct phone numbers



You can also consult our
Online-Catalog with over
45,000 products in stock.
www.eriks.nl

VALVES AND INSTRUMENTATION



+31 72 514 18 00
valves@eriks.nl

klepafsluiters
globe valves
gate valves
check valves
strainers
sight glasses
steam traps
reducing valves
safety valves
gauge glasses
overflow valves
vacuum and air relieve valves
ball valves
butterfly valves
pneumatic and electricactuators
diaphragm valves
pinch valves
measurement and regulation
components for: - pressure
- temperature
- flow
- level
control valves
solenoid valves

PLASTIC PIPING



+31 72 514 18 11
piping@eriks.nl

pipes and fittings of:
- Superflo ABS
- Air-Line Xtra
- PE
- PP
- PVC
- PVC-C
- PVDF
ball valves
diaphragm valves
butterfly valves
globe valves
check valves
strainers
overflow valves
reducing valves
solenoid valves
clamps
tools
cements
plastic tanks
wall sleeves
repair clamps

HOSES, ACCESSORIES AND EXPANSION JOINTS



+31 72 514 18 22
hoses@eriks.nl

hoses of:
- rubber
- plastic
- PTFE
- metal
hose couplings
coupling systems
hose clamps
hose reels
hose reel carts
hydraulic hoses
fittings and couplings for
hydraulics
expansion joints of:
- rubber
- metal
- fabric
- PTFE

INDUSTRIAL PLASTICS



+31 72 514 18 33
plastics@eriks.nl

semi-manufactured and finished
products of:
EriFlon-PTFE - PVDF - PCTFE
Ertalon - PA6 and PA66
Ertacetal - POM
Erylate - PETP
Nylatron
Fluorosint
Torlon
Techtron
PEEK/PSU/PEI
Meldin-PI
Trovidur/Epradur PVC
Multilene PE and PP
polycarbonate
acrylate - PMMA - PET
Epratex/Tufnol-PF (laminated fabric)
Hapa - PF (laminated paper)
RX® Grate/GVK (glass-fibre
reinforced plastics)
Erlan/Rhino Hyde®-PUR

FLANGEGASKETS, MECHANICAL SEALS AND PACKINGS



+31 72 514 18 44
seals@eriks.nl

metallic and semi-metallic
gaskets:
- spiral wound
- ring type joint
- serrated
- insulating sets
flange gaskets and die-cut
parts of:
- elastomers
- fibre sheet
- PTFE sheet/tape
- graphite sheet
stuffing-box packings
mechanical seals

DYNAMIC SEALS



+31 72 514 18 55
seals@eriks.nl

oil seals
Eri-sleeves shaft protecting
V-rings
PS seals
seals, guide parts and wipers
for hydraulic and pneumatic
cylinders
Multiseals
Omniseals® spring actuated
PTFE seals
end caps
KVSP Kalrez® valve stem
packings
lubricants
greases
leak detection sprays
liquid sealants

O-RINGS & TECHNICAL RUBBER



+31 72 514 18 66
seals@eriks.nl

rubber vormartikelen
rubber moulded parts
profiles of:
- cellular rubber
- sponge rubber
- solid rubber
inflatable seals
O-rings
X-rings
back-up rings
cords
adhesives
boxes of assorted O-rings
vibration absorbers

GENERAL



+31 72 514 15 14
info@eriks.nl

Should you need a product you
cannot find on this page, please
call one of our ERIKS Servicecenters
(see on the back of this cover).

ERIKS

know-how makes the difference



Oil Seals



ERIKS bv
PO Box 280
NL-1800 BK Alkmaar

T +31 72 514 15 14
F +31 72 515 56 45

info@eriks.nl
www.eriks.nl

Contents

ERIKS OIL SEALS TECHNICAL MANUAL

1. Introduction.....	3
2. Description and principle of Oil Seals	4
3. Construction of Oil Seals	5
4. Common types	6
5. Common materials	11
6. Shaft materials, seal tolerance and housing	14
7. Shaft eccentricity and shaft runout	15
8. Materials and tolerances of the shaft	16
9. Lubrication	17
10. Oil Seals for higher pressures	18
11. Split Oil Seals	19
12. Assembly of the Oil Seal	21
13. Troubleshooting	23
14. Conversion table inch / mm	24
15. Table of DIN dimensions	25

Disclaimer

The information provided in this document is for general information purposes only and does not constitute advice. ERIKS shall not be liable for any damages resulting from the use of this document, including but not limited to damages caused by any incorrectness or incompleteness of the provided information, unless such damage is the result of any wilful misconduct or gross negligence on part of ERIKS.

1. Introduction

ERIKS is known worldwide for its comprehensive range of seals including O-rings, rotary shaft seals, hydraulic and pump seals.

Since 1960, ERIKS have developed this range to include the following product lines:

- NBR Oil Seals in all standard types and sizes
- Viton® Oil Seals type GR and GRST, fully encapsulated
- Oil Seals of rubber/textile construction for heavy duty applications
- Oil Seals in non standard rubber compounds such as EPDM, XNBR, HNBR, Silicone, etc...
- ERIKS PTFE lip seals and PS Seals
- Oil Seals for higher pressures: VR Oil Seals
- End caps
- V-seals
- Alpha seals

In this documentation you will find the most relevant technical information regarding Oil Seals.

ERIKS has 9000 moulds to produce these standard Oil Seals as well as the production facilities to produce small quantities of non standard Oil Seals.

We will be pleased to give you the information you need.
You will be surprised by our keen prices!

2. Principle of Oil Seals

Oil Seals

One of the most frequently used types of seal is the Rotary Shaft Seal. This is generally used for sealing lubricating oil or grease in rotary shaft applications. In exceptional cases, it is also used to seal other fluids, gases and powdered or granular solids. For trouble-free operation and optimum service life of a seal, shafts must have a satisfactory surface finish, within recommended limits and have no machine lay. Both correct design and material choice are critical if bearings and gears are to be sealed to prevent the leakage of lubricating oils and greases and the ingress of penetrating dust and dirt.

Sealing

A good lubricating oil forms a strong tenacious film on gears, bearings and shafts and is not easily removed from the pressure bearing surfaces of these. However, where the shaft extends away from the equipment, this oil film must be retained. In Oil Seals, the pressure or radial load exerted by the sealing lip must be sufficient to retain the oil film, whilst not so high that excessive friction losses or wear can occur. Good Oil Seal design is therefore a balance between optimum running properties of the material, lip design and integral garter spring.

Working principle

During rotation of the shaft, a hydrodynamic film of lubricant is produced beneath the sealing lip, the thickness of which depends on shaft speed, oil temperature, oil viscosity and the pressure or radial load exerted by the sealing lip on the shaft. Due to capillary forces and the surface topography of the shaft, the fluid being sealed forms a meniscus under the sealing lip and is prevented from leaking. The fluid, the seal material, the film thickness, the sealing lip geometry and the surface topography of the shaft are governing factors in the realisation of these capillary forces. A used seal having a shiny wear flat with hardening and radial cracking is indicative that it had operated on a shaft which was too smooth and /or that the radial load exerted by the lip was too high. A used seal having a wide wear flat is indicative that it had operated on a shaft which was too rough, especially if there was no hardening or radial cracking and could also be associated with incorrect sealing lip geometry.

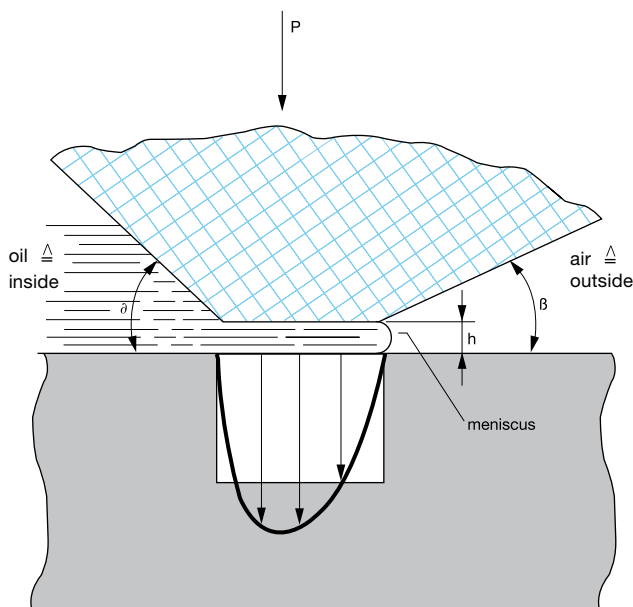

3. Construction of the oil seal

DIN 3760/3761

DIN 3760/3761 describes the standardisation of design, dimensions and tolerances of Oil Seals.

DIN Standard 3760		ERIKS TYPE
A	RUBBER COVERED	R
AS	AS TYPE A WITH DUST LIP	RST
B	METAL CASED DESIGN	M
BS	AS TYPE B WITH DUSTLIP	MST
C	DOUBLE METAL CASED	GV
CS	AS TYPE C WITH DUST LIP	GVST

TYPE R

The most commonly used type is type R. This type has a carbon steel insert and has rubber outside diameter. The rubber gives a good sealing capability, even when the housing is not fully in tolerance. The sealing lip with spring provides interference on the shaft for effective sealing. The outside diameter, with inner metal reinforcement case, allows press-fitting in the housing, with sufficient interference on the rubber to provide static sealing. The sealing element is produced from a high performance Nitrile rubber. This in combination with a high quality galvanised steel garter spring gives the ERIKS Oil Seal an optimum life. In order to prevent leakages due to a hydrodynamic pumping effect it is necessary that the sealing lip contact area on the sleeve or shaft is without any traces of machine lay.

Metal components

Depending on the application, ERIKS Oil Seals are supplied with various types of metal.

The reinforcing case

Carbon steel as standard but stainless steel or brass on demand.

TYPE GR

This type is fully covered with rubber on the inside of the reinforcing case. ERIKS GR Viton® Oil Seals are of this type and are fitted with a stainless steel garter spring. This type can also be supplied in Nitrile rubber on demand.

The garter spring

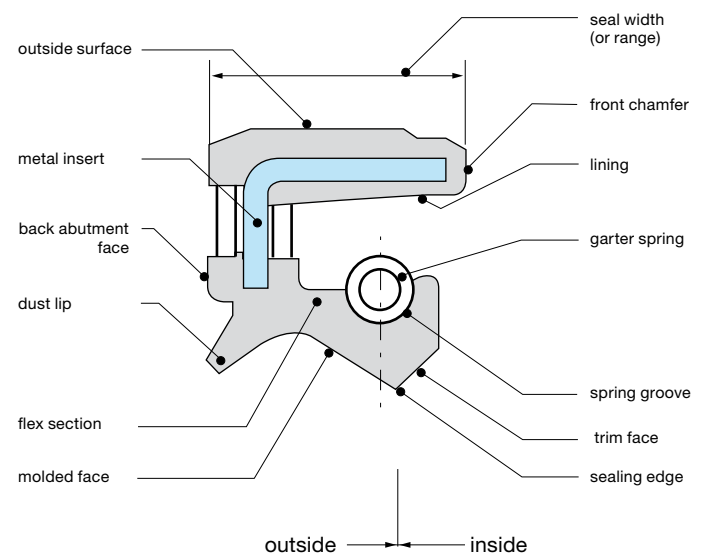

Galvanised steel as standard. Stainless steel, bronze or an elastomer can be supplied on demand.



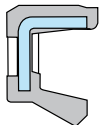
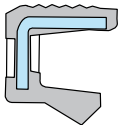
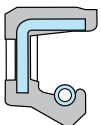
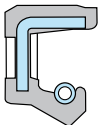
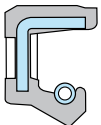
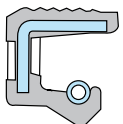
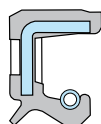
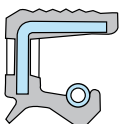
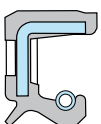
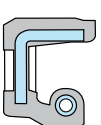

4. Common types

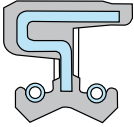
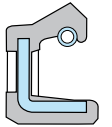
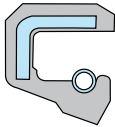

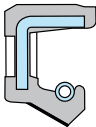
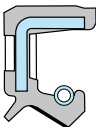

Part 1: Construction with outside rubber diameter

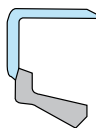
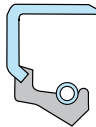
	ERIKS type	Description
	Type RZV	Smaller sizes only for applications such as needle bearings and grease seal.
	Type RGZV	Similar application as type RZV, but the outside surface has a ribbed design.
	Type R	Rubber outer diameter with a carbon steel insert. Construction is in accordance with DIN 3760A and available in both metric and inch sizes.
	Type R-RVS	Oil Seal with a RVS-304 spring
	Type R-O RING	Oil Seal with a rubber spring
	Type RG	Ribbed outer rubber surface. With this system the thermal expansion of the housing is absorbed. This is used in automotive applications.
	TYPE RST	Oil Seal with additional dust lip to prevent damage of sealing lip and to avoid the ingress of dust, dirt, water etc. into the system. Very commonly used in both metric and inch sizes.
	Type RGST	Identical application as type RST, but the outside rubber surface has a ribbed design to absorb thermal expansion of the housing.
	Type RST-D	Seals pressures to 10 bar (1MPa) depending on the circumstances because it is more compact than type RST. It is recommended that our application engineers should be contacted.
	Type RV	The helical spring is encapsulated in the seal. This is important when the seal has to be moved over almost the full shaft length, preventing both dislodgement of the spring and its contact with the medium to be sealed.

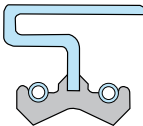
	ERIKS type	Description
	Type R-Duo	R type with two sealing lips, used for sealing two separate media. When the requested R-Duo type is not available, two R-types can be fitted back to back.
	Type REX	This type has to be mounted on the shaft, and has the seal lip on the outside. It is used in wheel seal applications and is frequently used in centrifuges.
	Type VITON® GR	Viton covered seal with completely encapsulated steel insert for high temperature and chemically aggressive applications; it is supplied with a stainless steel spring as standard. The Viton® used in the manufacture of Oil Seals is produced by DuPont Performance Elastomers.
	Type VITON® GRST	Similar to Viton GR, but with an additional dust lip to prevent damage to the sealing lip and to prevent ingress of dust into the system. It is supplied with a stainless steel spring as standard.
	Type R-T	Oil Seal with a PTFE face bonded to the synthetic rubber element to reduce friction and heat development. Not available from stock. Its application is in Formula 1 engines.
	Type RST-T	Similar to type R-T, but with additional dust lip. Not available from stock.

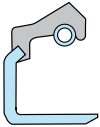
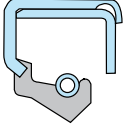
Part 2: Construction with outside metal surface

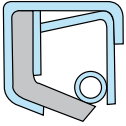
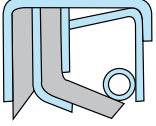
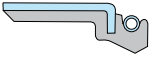
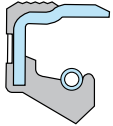
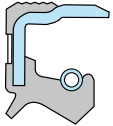
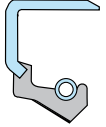
	ERIKS type	Description
	Type MZV	Smaller sizes only for applications such as needle bearings and grease seal.
	Type M	Metal cased standard Oil Seal with vulcanised sealing lips. This type is frequently replaced by type R.
	Type MST	Similar to type M but with additional dust lip. Applications are the same as type RST, when the requested type is not available.
	Type M-DUO	With two sealing lips, for sealing two separate media. Limited stock is available.

	ERIKS type	Description
	Type MEX	External sealing type, whereby the metal case is mounted on the shaft.
	Type GV	Totally enclosed metal casing for extra reinforcement, and a vulcanised rubber sealing lip. It is widely employed for larger shaft diameters for example in heavy industry such as roller bearings.
	Type GVST	Similar to type GV, but with additional dust lip.
	Type GVP	Oil Seal with double metal case and assembled rubber sealing lip. Seals low pressures as well. It is available in almost every size from at least 100 mm inside diameter.
	Type GVPST	Similar to type GVP, but with additional dust lip.
	Type VSS	Special type for sealing valve stems in engines. It is only produced on demand.
	Type MR	Oil Seal commonly used in engines. Press fitting of a metal case combined with a better internal sealing rubber case.
	Type MRST	Similar as type MR with additional dust lip.
	Type M-T	Oil Seal with a PTFE layer on the sealing lip to reduce friction and heat development. Its application is in Formula 1 engines. Not available from stock.
	Type MST-T	Similar to type M-T but with additional dust lip. Not available from stock.

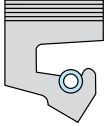
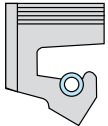
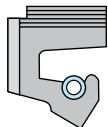

Part 3: Construction with fabric insert reinforcement

	ERIKS type	Description
	Type WR35	Outside surface with fabric insert reinforcement. Oil Seal without metal reinforcement. Split Seals also available. These are frequently installed back to back with a lock-in plate. They are available in NBR and FPM.
	Type WR36	Similar to type WR35, but additional grooves on the back side for optimal grease supply to the sealing lips when back-to-back mounted.
	Type WR37	Similar to type WR36, with grooves on the whole contour.

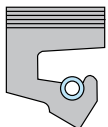
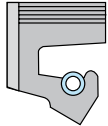
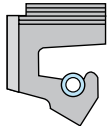
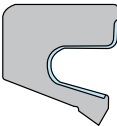
Part 4: Split construction “Split Seals”

	ERIKS type	Description
	WR35 Split	Similar to type WR35, but in split construction. Commonly used when dismantling is time consuming, for example roller bearings in the steel and paper industry, or marine propeller shafts.
	WR36 Split	Similar to type WR36, but in split construction.
	WR37 Split	Similar to type WR37, but in split construction.
	23 Split	Full rubber construction as standard type Oil Seal, with a helical spring. These are only available in a limited number of sizes.

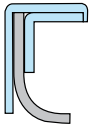
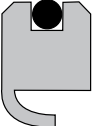
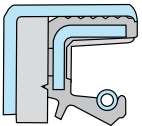
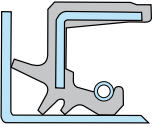
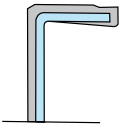
Part 5: diverse products

	ERIKS type	Description
	PTFE Lip seal	Stainless steel outer casing and modified PTFE lip. Applicable for up to 10 bar (1MPa)
	Dyna Lip seal	Made from modified PTFE without metal parts. These can be supplied with or without a Viton® O-ring on the outside diameter. Always assemble with lock-in plate.
	Combi Seal	A seal developed for extreme wear applications. The Oil Seal and dust seal are combined in one metal case, ready for use.
	Cassette Seal	Multilip construction with sleeve. Used as wheel seals in excavator applications.
	End cap	End cap is used to seal holes (in for example gear boxes). Assemble by press fitting, as Oil Seal with a rubber case.
	Erisleeve	Hard chromed stainless steel sleeves to use on worn shafts. They are available in almost every shaft diameter from 1/2" to 8".

5. Common Materials

In the standard construction, our Oil Seals are made from oil and grease resistant rubber based on NBR (Perbunan).

This material has very good running properties and excellent wear resistance. For high shaft speeds, large radial tolerances and good chemical resistance a range of other rubber materials is available.

Choice of material for Oil Seal

Rubber Type	Material Code ISO 1629	Heat resistance
Nitrile High wear resistance good running properties for general use	NBR	-35 °C tot + 100 °C
Polyacrylate Better heat, oil and chemical resistance than NBR It is recommended for use in oil which contains load bearing additives such as EP gear oils	ACM	-20 °C tot + 130 °C
Viton® High level of chemical resistance High temperature resistance	FPM	-30 °C tot + 180 °C
Silicone Wide temperature range Commonly used in low temperature applications Very prone to mechanical damage during fitting	MVQ	-50 °C tot + 150 °C
Polytetrafluoroethylene Chemical resistant Low coefficient of friction poor elastic properties not wear resistant if used by dynamic applications	PTFE	-80 °C tot + 200 °C
Leather Recommended for abrasive applications. Good running properties, due to the impregnated seal lip. Can be used on shafts which have a surface roughness outside the range for rubber Seals Not suitable for water.		-40 °C tot + 90 °C

Max. Temperature (°C) of the sealing medium

Elas-tomer	Min. temp.	Motor Oil	Gear-box oil SAE	ATF oil	Hypoid oil	Grease	Fuel	Water	Logen	Brake fluids
NBR	-35	100	80	100	80	90	90	70	70	-
ACM	-20	130	120	130	120	*	*	-	-	-
MVQ	-50	150	130	*	-	*	*	-	-	-
FPM	-30	180	150	170	150	*	150	100	100	*

- = For these media the elastomer is not resistant

* = Within these groups, there are media which can be sealed by the elastomer in question, although these media could have a disadvantageous influence on the elastomer.

The choice of the right elastomer

Next points are important

1. Under lip temperature caused by friction
2. Shaft speed
3. Temperature of the medium
4. Chemical influence of the medium
5. Pressure on the seal

The following table may help to determine the peripheral speed at a given shaft diameter and rotational speed.

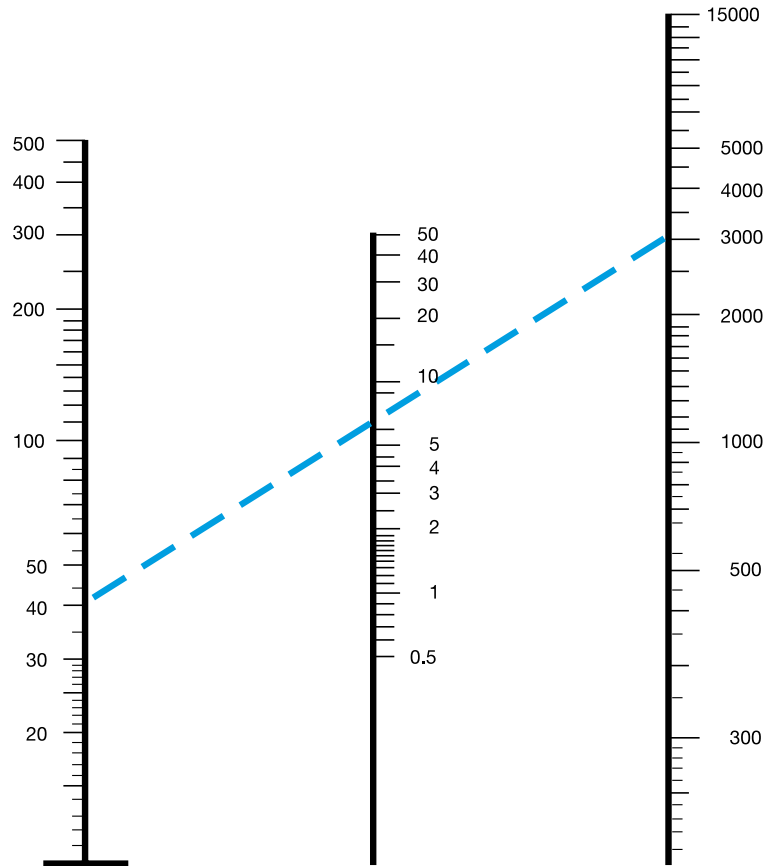

Example: the peripheral speed of a shaft of 40 mm diameter with a speed of 3000 revolutions per minute is 6.5 metres per second.

Allowable peripheral speeds and surface speeds

Shaft speeds which may be permitted, related to the rubber material in the case of non-pressure conditions (with good lubricating mineral oil and a good flow of lubricant), is shown in the next figure.

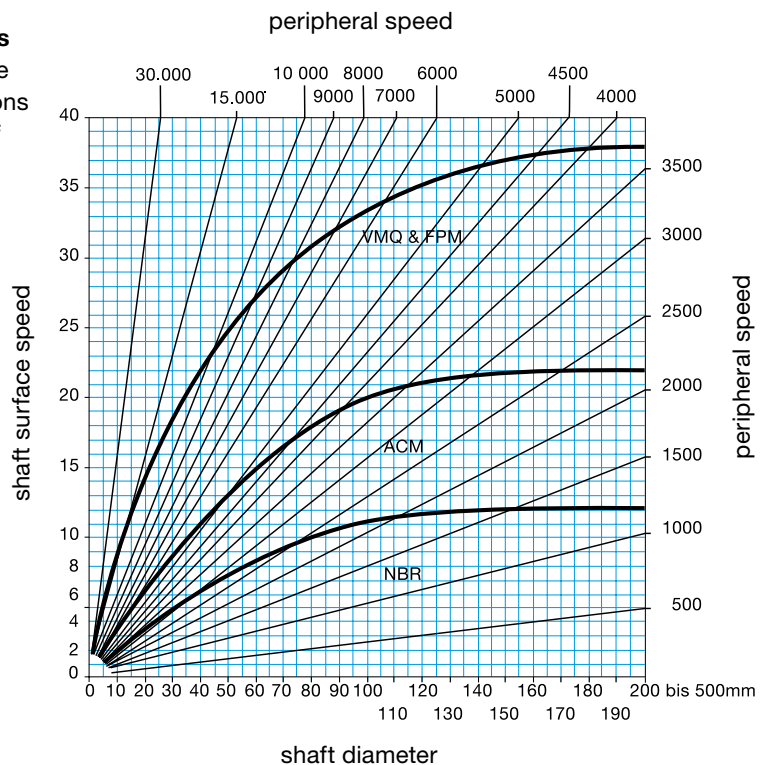

* = Oil will convey the heat better than grease

6. Shaft materials, tolerances of seals and housing

The housing of the Oil Seal

The size of the housing where the Oil Seal has to be pressed in has to meet certain requirements. The housing has to be rather smooth (finely machined). Nominal tolerances according to ISO H8.

	Roughness	tolerance of the passing
Shaft	$Ra \leq 0,6 \mu\text{m}$	h11
Housing	$Ra \leq 6 \mu\text{m}$	H 8

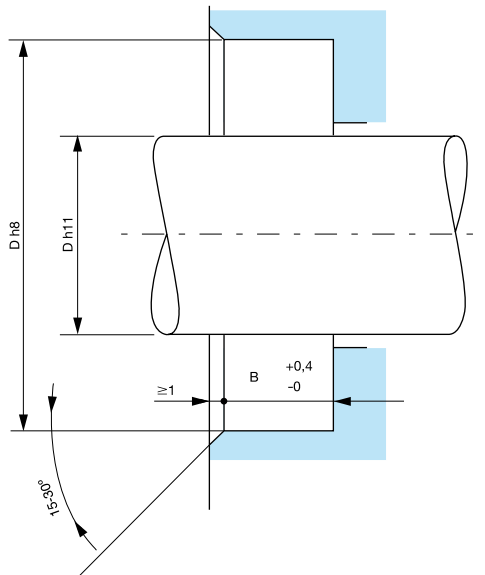

To simplify the assembly, it is recommended that the housing is lubricated. The housing should have a finish of ca. $Ra = 6\mu\text{m}$. Oil Seals with a rubber case cannot rust, in contrast to Oil Seals with metal cases. Moreover, Oil Seals with a rubber case can seal a lightly damaged housing much better than metal cased Oils Seals.

To simplify the correct assembly of the Oil Seal, it is recommended that the housing has a 30° chamfer on the front side for a minimum length of 1mm. The Oil Seal, when mounted, has to fall within the limits of this chamfer. For the assembly depth, there is a tolerance of -0/0,4mm. The Oil Seals have an interference fit in the housing, which provides a good press fit, preventing any leakage.

Excessive and permitted ovality on the outside diameter (data according to DIN 3760)

Outside Diameter oil seal (D)	Press fit			Permitted ovality (for all types)
	R	M	GV	
< 50 mm	+0,30/+0,15	+0,20/+0,10	+0,20/+0,10	0,25
50 - 80 mm	+0,35/+0,20	+0,23/+0,13	+0,23/+0,13	0,35
80 - 120 mm	+0,35/+0,20	+0,25/+0,15	+0,25/+0,15	0,5
120 - 180 mm	+0,45/+0,25	+0,28/+0,18	+0,28/+0,18	0,65
180 - 300 mm	+0,45/+0,25	+0,30/+0,20	+0,30/+0,20	0,8
300 - 500 mm	+0,55/+0,30	+0,35/+0,23	+0,35/+0,23	1

The outside diameter should be measured in at least two places, with an angle of 90° between each measurement. The mean of both measurements is determined, where the permitted ovality may not be exceeded.

7. Eccentricity and shaft oscillation

Eccentricity

It is obvious that the centre lines of the housing, Oil Seal and shaft have to coincide as much as possible. The sealing element of the Oil Seal will only tolerate a minimum deviation. The maximum permitted eccentricity is dependent on the size of the shaft and the type of Oil Seal. In this case, we assume static eccentricity, and no shaft runout.

ERIKS has special types of Oil Seals, which are suitable for applications with large shaft eccentricity and runout. Information on all the possibilities is available.

Shaft oscillation

When shaft runout is present, seals with a loose garter spring are preferred to seals with an encapsulated spring. The runout should remain within the limits. "A" represents the difference between the centre line of the housing bore and the centre line of the shaft in the region of the seal line. The two centre lines do not run parallel. The permitted maximum value of A depends on the rotational speed, the dimensions of the shaft and the Oil Seal.

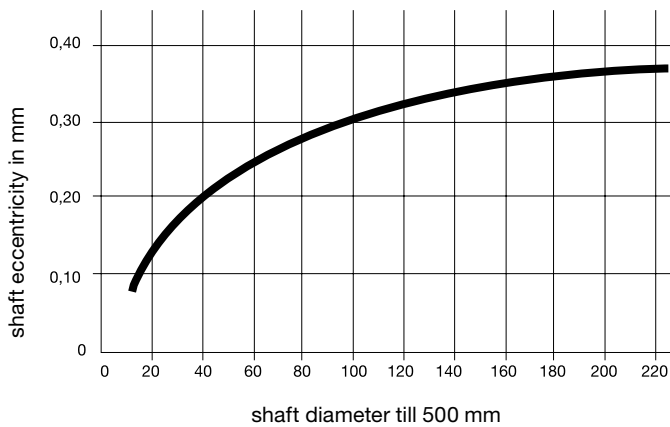
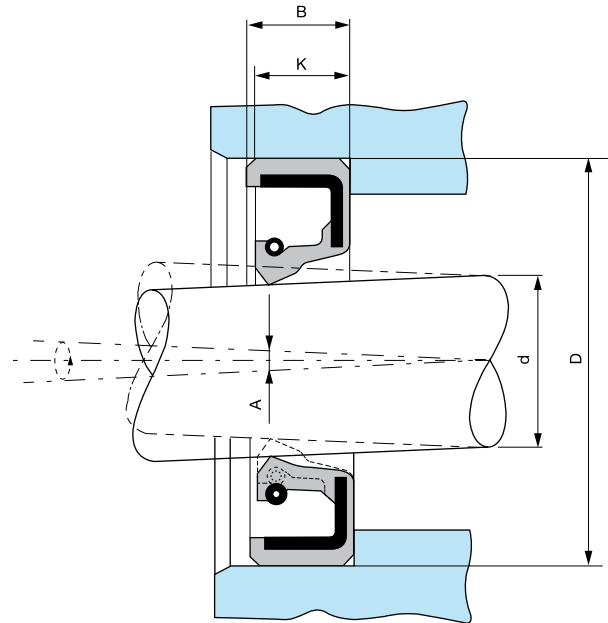
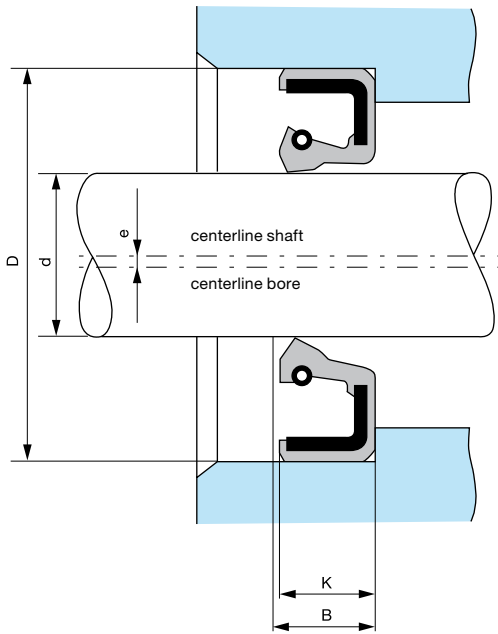

Above diagram shows the maximum allowable eccentricity

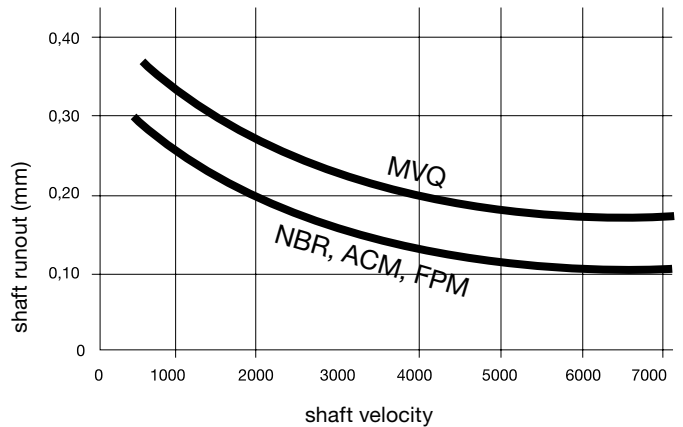

Above diagram shows the maximum allowable shaft run out

8. Shaft materials and tolerances

Material

The rubber material of the Oil Seal is much softer than the shaft, but due to friction between the shaft and the seal, it is possible for wear to occur on the contact surface of the shaft. The degree of wear depends on the structure of the shaft material. In general, the metal from which the shaft is made should have a homogeneous fine granulous structure and must have a minimum surface hardness of HRc 45. If the lubrication is doubtful, the medium is contaminated, dirt can enter from the outside and the speed of the shaft is more than 4 m/sec, the hardness of the shaft should be a minimum of HRc 55. In general, shafts of carbon steel or stainless steel are most suitable. Surface hardening is recommended. In the case of hard chromed shafts, the uniformity of the chrome plating has to meet very high requirements. In practice, such surfaces do not meet these optimum requirements. Coated shafts, for example with chrome oxide (ceramics) have to be carefully machined. The coating should not have pores larger than 0,05 mm. This is also the case for the surface of cast iron with a perlitic structure. In some cases, non-ferrous metals such as brass MS 58H are used. Ceramic sleeves and Erisleeves are very useful as too. Erisleeves are used in both original equipment assembly and repair.

Comment: Plastics are unsuitable due to their poor thermal conductivity. Because of this, underlip heat generation cannot be readily conducted away, which is not desirable.

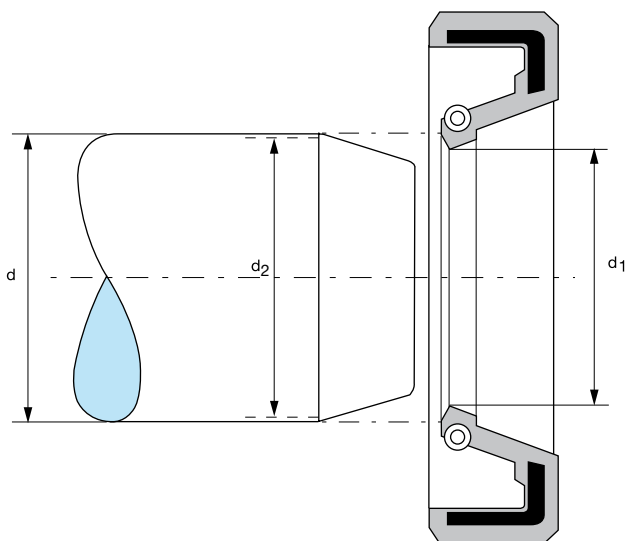

Requirements of the shaft

Even more important than a correct interference fit of the Oil Seal is a perfectly smooth shaft in the region of the seal, particularly if shaft surface speed is high and the medium to be sealed is under a certain amount of excess pressure. The surface roughness of the shaft depends on the average profile depth Ra of the tool marks caused by the machining process. Oil Seals made of PTFE require, independent of the surface speed, a surface roughness of between 0,1 to 0,2µm, because PTFE has less wear resistance than rubber seals.

For normal circumstances, the shaft in the region of the seal must have a surface roughness of approximately:

Ra	= 0,4 - 0,8 µm or -
CLa	= 8 tot 25 µm or
Rz	= 1,0 tot 4,0 µm and
Rmax	≤ 6,3 µm

To summarize, the surface of the shaft in the region of the seal should not have noticeable machining marks. For pivoting shafts and other difficult or critical sealing applications, it is recommended that Oil Seals with a helical groove hydrodynamic pattern, which has a pumping effect, be used. When grinding and polishing, an axial movement of the grindstone along the shaft must be avoided in order to prevent machine lay.

Tolerances

The sealing capacity of an Oil Seal also depends on the pressure exerted by the sealing lip on the shaft. The degree of pressure is directly related to the interference and the dimensional tolerances of Oil Seal and shaft. Interference is the difference between the shaft diameter and the inside diameter of the sealing lip ($d - d_1$), see figure 10.

Where problems occur and a free running seal is essential, despite risk to sealing capacity, the shaft diameter may be reduced as long as at least 1/3rd of the minimum interference is preserved (d_2)

Comment: the shaft in the region of the Oil Seal must have a dimensional tolerance of h11.

9. Lubrication

Oil seals for rotating or reciprocating shafts require a certain degree of lubrication of the moving surfaces.

Oil Seals must never run dry

When seals are adjacent to bearings, the bearing lubricant will generally provide sufficient lubrication for the seal. Sealing water as well, most of the time there is enough lubrication. However, in isolated locations or applications involving non-lubricating medium, provision should be made for lubricant to reach the seal. In such case, dual seals frequently provide an answer as the space between the sealing edges can be pre-packed with grease thus allowing a considerable period of operation without further attention. In such instances, the Oil Seals should be mounted in such a way that no pressure build-up can occur when adding the grease.

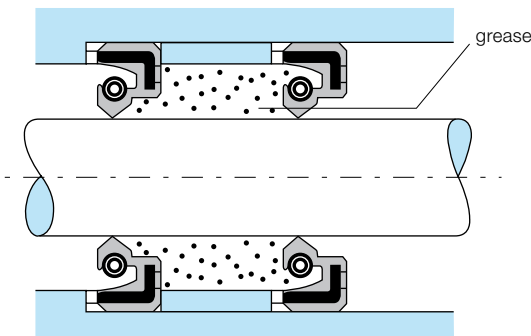

The presence of lubrication is important, not only during operation, but during assembly as well. Never assemble an Oil Seal dry. Both the shaft and the Oil Seal have to be lubricated with oil or grease in advance. This eases the assembly and ensures lubrication from the beginning.

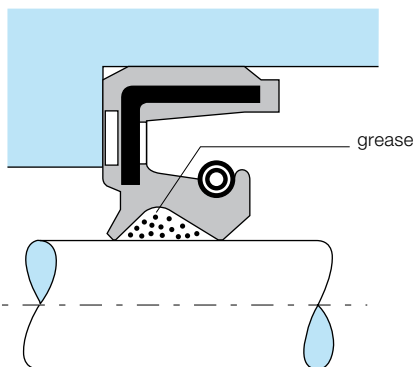

If Oil Seals with fixed dust lips are being used, the space between the sealing lip and the dust lip may also be filled entirely with grease. The medium to be sealed will dissipate the heat developed.

Friction losses

Because the sealing principle of Oil Seals relies on the friction between the sealing lip and shaft with a minimal fluid film, friction losses are inevitable. For a given shaft diameter and a given speed of rotation, the friction coefficient depends on the friction of the Oil Seal with respect to the shaft.

Determining factors are:

- the characteristics of the Oil Seal and the shaft materials
- the surface roughness of the shaft
- the presence and the characteristics of the lubricating film
- the pressure of the medium to be sealed
- the degree of interference of the sealing lip
- the operating temperature

It is difficult to measure precise values. However, the graph below gives useful information concerning friction losses of standard Oil Seals used in standard quality oil SAE-30 at 100°C on a correctly prepared shaft, after a short time of running in.

The graph shows the relationship between the power loss, shaft diameter and shaft speed.

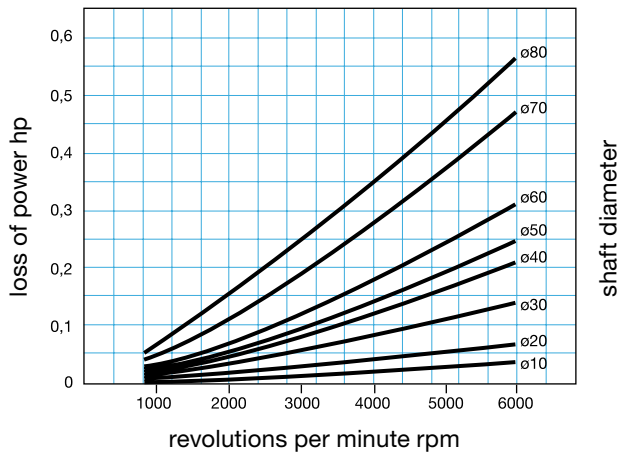

10. Oil Seals for higher pressures

An Oil Seal is principally intended for operating under normal atmospheric conditions. If however the peripheral speed does not exceed 8 metres per second, the Oil Seal can cope with a pressure of ca. 0,5 bar. In the case of large shaft diameters (500 mm,) the permissible pressure which the Oil Seal may be exposed to is 0,1 bar.

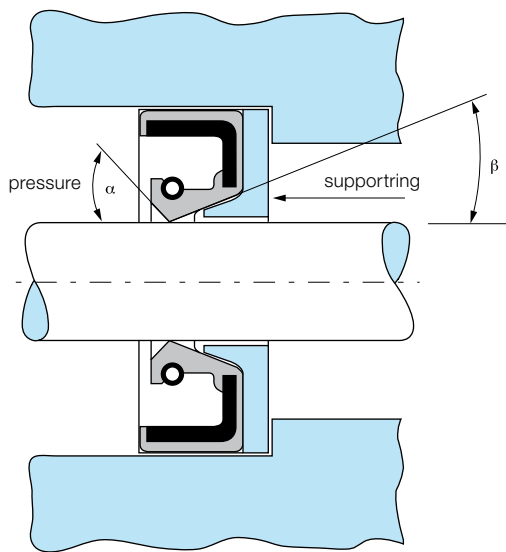

The permissible pressure greatly depends on the operating conditions such as shaft speed, temperature and lubrication.

If the actual pressure exceeds the permissible maximum, the lip of the Oil Seal is forced against the shaft, resulting in a higher radial load, a higher level of friction and excessive wear of shaft and seal. To balance the pressure, Oil Seals can be provided with a supported sealing lip by using an easily fabricated metal support ring.

Oil Seals with a supported sealing lip can be used on small diameter shafts for pressures up to 6 bar if conditions are favourable (low temperatures, relatively low speed, good lubrication)

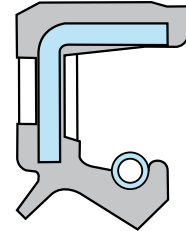

type Rst-D

Due to the small size and the strengthened hinge point, Oil Seal type RST-D can, under favourable circumstances, be used up to a maximum of 10 bar.

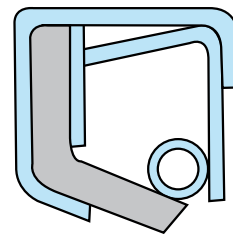

type GVP

The metal case of the ERIKS-type GVP is dished under the sealing lip, providing a built in supporting ring (especially for shaft diameters >80mm).

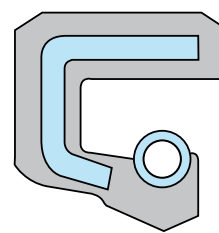

type RD

The type RD has an encapsulated metal support ring. This type is extremely suitable for smaller shaft diameters. This design is only available on demand.

11. Split Oil Seals

Split Oil Seals are most frequently used in situations where dismantling is too difficult, such as in the steel industry, paper industry, heavy excavators or marine propellers shafts.

ERIKS has a wide variety of Split Oil Seals

	WR35 Split: Insert fabric reinforced. Commonly used when dismantling is very time consuming, for example roller bearings in the steel and paper industry, or marine propeller shafts.
	WR36 Split: Similar to type WR35 Split, but with more grooves for optimal grease supply to the sealing lips when back-to-back mounted.
	WR37 Split: Similar to type WR36 Split, but with grooves on the whole contour.
	23 Split: Full rubber design as standard type Oil Seal, but with a stainless steel wave spring. It is available in NBR and FPM.
	VR-Split: Full rubber design as standard type Oil Seal, but with a stainless steel garter spring. It is only available in a limited number of dimensions.

ERIKS Split Seals are available in both NBR and FPM metric and inch sizes.

Split Seals cannot be mounted like the standard types (DIN), by means of press fitting in the housing. Split Seals must be locked by means of a lock-in plate (see figure).

Type R23 split

The most common type is ERIKS type R23 split. This type has a full rubber profile with an encapsulated wave spring. This design is available in both metric and inch sizes in NBR and FPM.

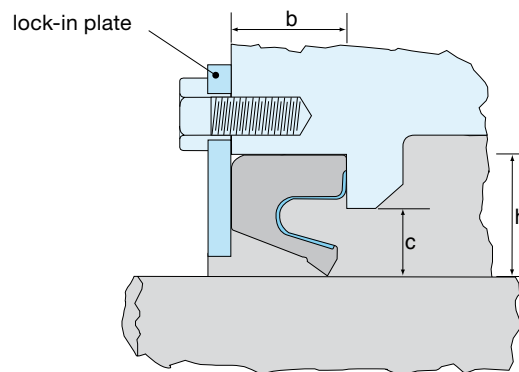

Recommended profile dimensions

Shaft diameter	range		
	Radial height	Axial height	Size
(h1) mm	h	w	c (max.)
75 - 250 mm	12,5 mm	12,5 mm	7,5 mm
120 - 350 mm	15 mm	15 mm	10 mm
250 - 500 mm	20 mm	20 mm	10 mm
500 - 1500 mm	25 mm	20 mm	10 mm

ERIKS Split Seals R23-split are supplied with an oversize end are flush mounted. As a result, ERIKS Split Seals type R23-split, in non-pressure applications, seal reliably on the seam. In very critical situations we recommend that you lime the ends with a lime out our Sicomet program.

ERIKS R23-Split Seals are easy to cut and can be tailored to suit the required size by cutting from a bigger ring.

Type with insert fabric reinforcement

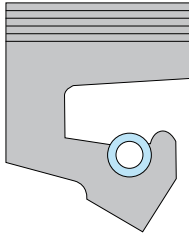

All the insert fabric reinforcement Oil Seals (general, and Split Seals) are supplied with a height size which is 0,5 to 0,6 mm larger than dimension b. The lock-in plate re-forms the Oil Seal diametrically which ensures reliable sealing on the shaft and the housing in service.

ERIKS insert fabric reinforcement Oil Seals type WR 35 split, type WR 36 split and type WR 37 split are moulded and are provided with a seam. If the desired size is not available in the list, please contact us. ERIKS has more sizes than listed. Please allow a delivery time of 8 to 16 weeks.

When assembling these Split Seals, it is necessary to remove the garter spring from the sealing lip and then re-fit it when the seal has been mounted over the shaft.

Comment: Please take into account that with this type of Split Seal, the seam, when mounted on the shaft, must be at the top (12 O'clock). Moreover, the medium to be sealed must not be above the centre line of the shaft.

Type VR split

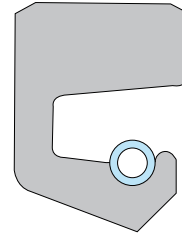

For the assembly of these Split Seals, it is necessary to remove the garter spring from the sealing lip and then re-fit it when the seal has been mounted on the shaft.

Comment: Please take into account that with this type of Split Seal, the seam, when mounted on the shaft, must be at the top (12 O'clock). Moreover, the medium to be sealed must not be placed above the centre line of the shaft.

ERIKS Split Seals type VR-Split are manufactured completely from rubber, where the outside of the Oil Seal has a hardness of 90° Shore "A" and the inside body and the sealing lip has a hardness of is 70° Shore "A". This design as well the sealing lip is centred by a helical spring.

ERIKS Split Seals type VR-Split are available in a limited number of sizes. We recommend that you to inform us of your requirements before you choose one of these types of seals.

12. Assembly of the Oil Seal

That the assembly of oil seals has to be done with a lot of care speaks for itself. The Oil Seal, the shaft and the housing have to be clean. Dirt, which may enter the system during assembly between the sealing lip and the shaft, can cause leakage.

Because the inside diameter of the Oil Seal during assembly has to be stretched, is it necessary that the shaft has a chamfer. The angle for the chamfer is approximately 30° to 50°.

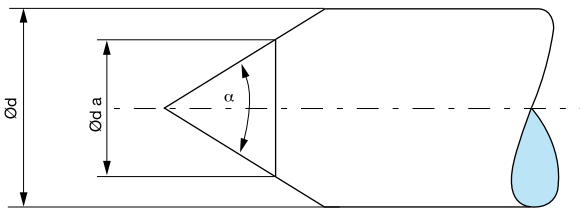

$\alpha = 30 \text{ à } 50^\circ$
to round the edge

When a spline on the shaft is present, a mounting sleeve must be used to protect the sealing lip. The housing chamfer must have a length of at least 1 mm. The sides have to be obtused.

During assembly, it is essential to prevent damage to the oil seal. If the Oil Seal must pass over irregularities such as screw-thread or splines, the shaft must be covered with oil soaked paper, tape, or with a protective socket or mounting sleeve made of metal or plastic.

The pressing of the Oil Seal into the housing has to be done evenly. Preferably, an adapted fitting tool should be used, so that the pressure is transferred through the part of the Oil Seal which is reinforced with metal.

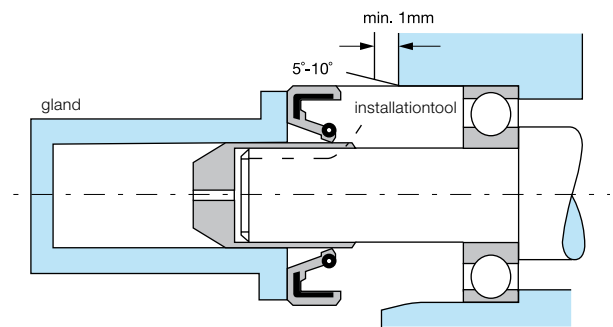

In order for the Oil Seal operate correctly; the sealing lip material has to be compatible with the medium to be sealed. To improve the sliding over the shaft, it is required that both the shaft and the sealing lip are lubricated with oil or grease. Oil Seals with a leather sealing lip have to be oil-soaked in advance.

Recommended methods

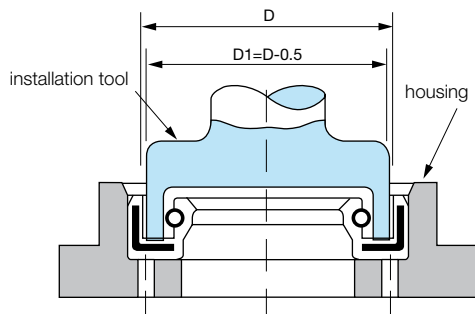
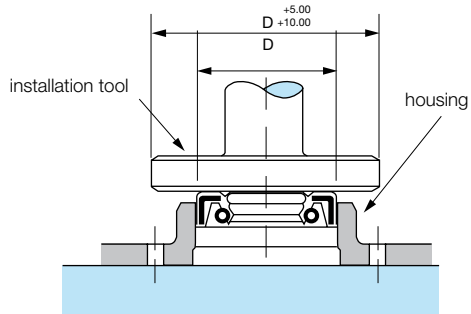
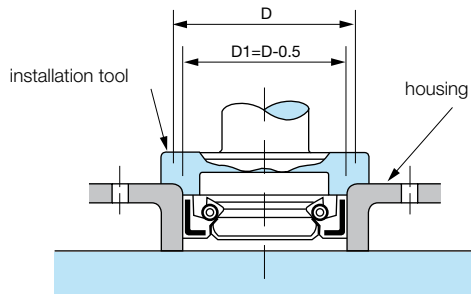
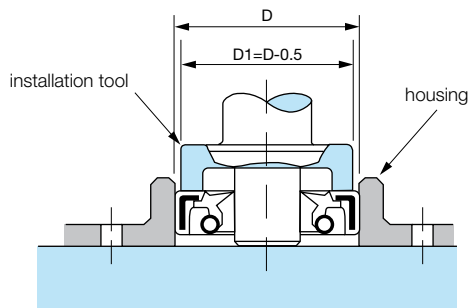

Incorrect methods

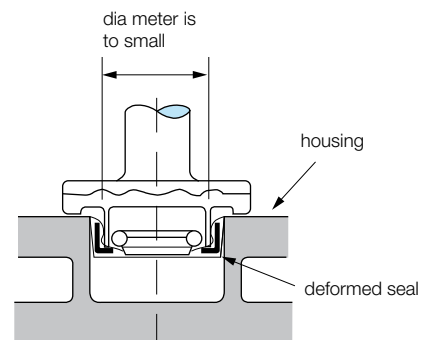
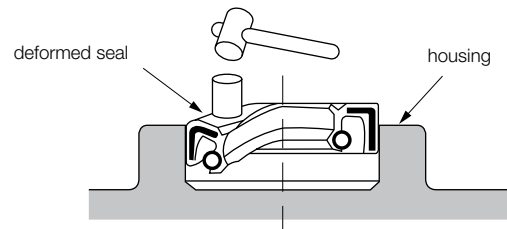
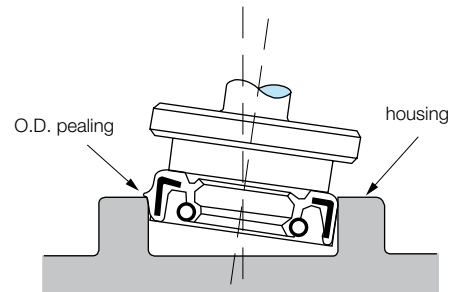
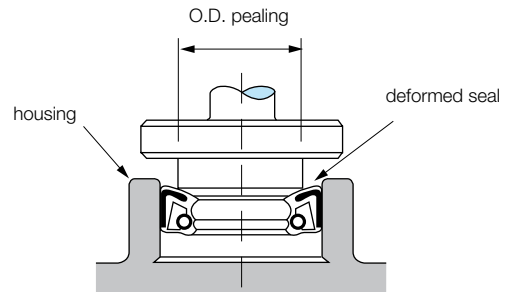

When an Oil Seal with a metal case (ERIKS types M and GV) is used, it is recommended to apply an Omnifit-fastening product. Lubrication of the shaft will have a beneficial effect during the running-in of the seal. When using a rubber hammer, the lubrication must be applied evenly.

Comment: An Oil Seal may not be force into the housing. By greasing the housing, the assembly will be easier.

13. Troubleshooting

There are two potential leak paths on an oil seal, i.e. between the outside diameter of the Oil Seal and the housing (static), and between the sealing lip and the shaft (dynamic).

In the table below the causes are listed, with a few recommendations to prevent these problems.

Symptoms	Cause	Remedy
Oil Seal rotates with the shaft	Outside diameter is smaller than the housing diameter	Replace the Oil Seal, choose the right size
Oil Seal is moving in an axial direction on the shaft	Outside diameter is smaller than the housing diameter	Replace the Oil Seal, choose the right size
	Due to excess pressure the Oil Seal is moving axially	
The mounted Oil Seal is deformed	Inside diameter of the Oil Seal is too small	Control the size of the shaft
The case of the Oil Seal is deformed	Wrong installation tools has been used	Use the right tools
Damaged surface of the Oil Seal	The finishing has not been executed properly	Control the roughness of the housing and the presence of a chamfer
	Dirt at the in- our outside of the housing	Clean all parts before assembly
Damaged sealing lip	Insufficient lubrication	Lubricate sufficiently
	Construction limits the transport of the lubrication to the sealing lip	Change the construction so that sufficient lubrication reaches the sealing lip
Partly damaged sealing lip	Oil Seal not placed concentric with regards to the housing	Centre the seal, use the right tools
Sealing lip has hardened, is worn out and is torn	To high temperature, shaft speed, pressure	Choose the right rubber compound and type of Oil Seal
	Insufficient lubrication	Lubricate sufficiently
Swollen sealing lip	Incorrect rubber compound	Choose the correct material
Scraped sealing lip	Roughness of the shaft is incorrect	Control roughness
	Incorrect tools used during assembly	Choose correct assembly tool
Collapsed sealing lip	Incorrect assembly	Lubricate before the assembly
	Too high pressure	Choose an Oil Seal for high pressures
The flexible part is torn	Too high pressure	Choose an Oil Seal for high pressures
	Pressure directed at the flexible part	
Garter spring out the groove	Chamfer does not have the correct angle	Use a mounting sleeve, or make a chamfer on the shaft
	Incorrect assembly	Take care during the assembly
	Grooves not deep enough	Choose another design, or use a spring with a smaller diameter

14. Conversion table inch / mm

inches	0	1	2	3	4	5	6	7	8	9
0	-	25.400	50.800	76.200	101.600	127.000	152.400	177.800	203.200	228.600
$\frac{1}{64}$	0.397	25.797	51.197	76.597	101.997	127.397	152.797	178.197	203.597	228.997
$\frac{1}{32}$	0.794	26.194	51.594	76.994	102.394	127.794	153.194	178.594	203.994	229.394
$\frac{3}{64}$	1.191	26.591	51.991	77.391	102.791	128.191	153.591	178.991	204.391	229.791
$\frac{1}{16}$	1.588	26.988	52.388	77.788	103.188	128.588	153.988	179.388	204.788	230.188
$\frac{5}{64}$	1.984	27.384	52.784	78.184	103.584	128.984	154.384	179.784	205.184	230.584
$\frac{3}{32}$	2.381	27.781	53.181	78.581	103.981	129.381	154.781	180.181	205.581	230.981
$\frac{7}{64}$	2.778	28.178	53.578	78.978	104.376	129.778	155.178	180.578	205.978	231.778
$\frac{1}{8}$	3.175	28.575	53.975	79.375	104.775	130.175	155.575	180.975	206.375	231.375
$\frac{9}{64}$	3.572	28.972	54.372	79.772	105.172	130.572	155.972	181.372	206.772	232.172
$\frac{5}{32}$	3.969	29.369	54.769	80.169	105.569	130.969	156.369	181.769	207.169	232.569
$\frac{11}{64}$	4.366	29.766	55.166	80.566	105.966	131.366	156.766	182.166	207.566	232.966
$\frac{3}{16}$	4.763	30.163	55.563	80.963	106.363	131.763	157.163	182.563	207.963	233.363
$\frac{13}{64}$	5.159	30.559	55.959	81.359	106.759	132.159	157.559	182.959	208.359	233.759
$\frac{7}{32}$	5.556	30.956	56.356	81.756	107.156	132.556	157.956	183.356	208.756	234.156
$\frac{15}{64}$	5.953	31.353	56.753	82.153	107.553	132.953	158.353	183.753	209.153	234.553
$\frac{1}{4}$	6.350	31.750	57.150	82.550	107.950	133.350	158.750	184.150	209.550	234.950
$\frac{17}{64}$	6.747	32.147	57.547	82.947	108.347	133.747	159.147	184.547	209.947	235.347
$\frac{9}{32}$	7.144	32.544	57.944	83.344	108.744	134.144	159.544	184.944	210.344	235.744
$\frac{19}{64}$	7.541	32.941	58.341	83.741	109.141	134.541	159.941	185.341	210.741	236.141
$\frac{5}{16}$	7.938	33.338	58.738	84.138	109.538	134.938	160.338	185.738	211.138	236.538
$\frac{21}{64}$	8.334	33.734	59.134	84.534	109.934	135.334	160.734	186.134	211.534	236.934
$\frac{11}{32}$	8.731	34.131	59.531	84.931	110.331	135.731	161.131	186.531	211.931	237.331
$\frac{23}{64}$	9.128	34.528	59.928	85.328	110.728	136.128	161.528	186.928	212.328	237.728
$\frac{3}{8}$	9.525	34.925	60.325	85.725	111.125	136.525	161.925	187.325	212.725	238.125
$\frac{25}{64}$	9.922	35.322	60.722	86.122	111.522	136.922	162.322	187.722	213.122	238.522
$\frac{13}{32}$	10.319	35.719	61.119	86.519	111.919	137.319	162.719	188.119	213.519	238.919
$\frac{27}{64}$	10.716	36.116	61.516	86.916	112.316	137.716	163.116	188.516	213.916	239.316
$\frac{7}{16}$	11.113	36.513	61.913	87.313	112.713	138.113	163.513	188.913	214.313	239.713
$\frac{29}{64}$	11.509	36.909	62.309	87.709	113.109	138.509	163.909	189.309	214.709	240.109
$\frac{15}{32}$	11.906	37.306	62.706	88.106	113.506	138.906	164.306	189.706	215.106	240.506
$\frac{31}{64}$	12.303	37.703	63.103	88.503	113.903	139.303	164.703	190.103	215.503	240.903
$\frac{1}{2}$	12.700	38.100	63.500	88.900	114.300	139.700	165.100	190.500	215.900	241.300
$\frac{33}{64}$	13.097	38.497	63.897	89.297	114.697	140.097	165.497	190.897	216.297	241.697
$\frac{17}{32}$	13.494	38.894	64.294	89.694	115.094	140.494	165.894	191.294	216.694	242.094
$\frac{35}{64}$	13.891	39.291	64.691	90.091	115.491	140.891	166.291	191.691	217.091	242.491
$\frac{9}{16}$	14.288	39.688	65.088	90.488	115.888	141.288	166.688	192.088	217.488	242.888
$\frac{37}{64}$	14.684	40.084	65.484	90.884	116.284	141.684	167.084	192.484	217.884	243.284
$\frac{19}{32}$	15.081	40.481	65.881	91.281	116.681	142.081	167.481	192.881	218.281	243.681
$\frac{39}{64}$	15.478	40.878	66.278	91.678	117.078	142.478	167.878	193.278	218.678	244.078
$\frac{1}{8}$	15.875	41.275	66.675	92.075	117.475	142.875	168.275	193.675	219.075	244.475
$\frac{41}{64}$	16.272	41.672	67.072	92.472	117.872	143.272	168.672	194.072	219.472	244.872
$\frac{21}{32}$	16.669	42.069	67.469	92.869	118.269	143.669	169.069	194.469	219.869	245.269
$\frac{43}{64}$	17.066	42.466	67.866	93.266	118.666	144.066	169.466	194.866	220.266	245.666
$\frac{11}{16}$	17.463	42.863	68.263	93.663	119.063	144.463	169.863	195.263	220.663	246.063
$\frac{45}{64}$	17.859	43.259	68.659	94.059	119.459	144.859	170.259	195.659	221.059	246.459
$\frac{23}{32}$	18.256	43.656	69.056	94.456	119.856	145.256	170.656	196.056	221.456	246.856
$\frac{47}{64}$	18.653	44.053	69.453	94.853	120.253	145.653	171.053	196.453	221.853	247.253
$\frac{3}{4}$	19.050	44.450	69.850	95.250	120.650	146.050	171.450	196.850	222.250	247.650
$\frac{49}{64}$	19.447	44.847	70.247	95.647	121.047	146.447	171.847	197.247	222.647	248.047
$\frac{25}{32}$	19.844	45.244	70.644	96.044	121.444	146.844	172.244	197.644	223.044	248.444
$\frac{51}{64}$	20.241	45.641	71.041	96.441	121.841	147.241	172.641	198.041	223.441	248.841
$\frac{13}{16}$	20.638	46.038	71.438	96.838	122.238	147.638	173.038	198.438	223.838	249.238
$\frac{53}{64}$	21.034	46.434	71.834	97.234	122.634	148.034	173.434	198.834	224.234	249.634
$\frac{27}{32}$	21.431	46.831	72.231	97.631	123.031	148.431	173.831	199.231	224.631	250.031
$\frac{55}{64}$	21.828	47.228	72.628	98.028	123.428	148.828	174.228	199.628	225.028	250.428
$\frac{7}{8}$	22.225	47.625	73.025	98.425	123.825	149.225	174.625	200.025	225.425	250.825
$\frac{57}{64}$	22.622	48.022	73.422	98.822	124.222	149.622	175.022	200.422	225.822	251.222
$\frac{29}{32}$	23.019	48.419	73.819	99.219	124.619	150.019	175.419	200.819	226.219	251.619
$\frac{59}{64}$	23.416	48.816	74.216	99.616	125.016	150.416	175.816	201.216	226.616	252.016
$\frac{15}{16}$	23.813	49.213	74.613	100.013	125.413	150.813	176.213	201.613	227.013	252.413
$\frac{61}{64}$	24.209	49.609	75.009	100.409	125.809	151.209	176.609	202.009	227.409	252.809
$\frac{31}{32}$	24.606	50.006	75.406	100.806	126.206	151.606	177.006	202.406	227.806	253.206
$\frac{63}{64}$	25.003	50.403	75.803	101.203	126.603	152.003	177.403	202.803	228.203	253.603

15. Table of DIN dimensions

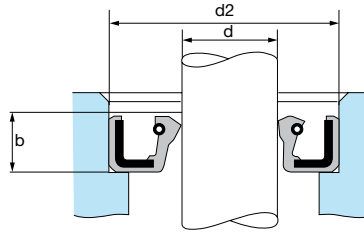

shaft diameter d	d_2	b $\pm 0,2$	shaft diameter d	d_2	b $\pm 0,2$	shaft diameter d	d_2	b $\pm 0,2$		
6	16	7	35	47	7	95	120	12		
	22			125						
7	22	7		100		120	12			
8	22	7		55	8	105		125		
	24			26						
9	22	7		50	8	110	130	12		
10	22	7		38	52	7	115	130	12	
	25				55			140		
	26				62			140		
12	22	7		40	55	8	120	150	12	
	25		62		150					
	30		62		160					
14	24	7	42	52	7	135	170	12		
	30			55			170			
	15			26			7		62	8
30		52		150						
35		55		160						
16	30	7		45	62	8	170	200	15	
	18		30		62			180		210
			35		62			190		220
20	30	7	48	60	8	200	230	15		
	35			62			210		240	
	40			65			220		250	
	22			35			7		50	62
40		65	240	270						
47		68	250	280						
25		35	7	55	72	8		260		300
	40	70			280		320			
	47	72			300		340			
	28	40			7		60		80	8
47		75	340	380						
52		80	360	400						
30		40	7	65		85		8	380	
	42	85			400	440				
	47	90			420	460				
	52	90			440	480				
32	45	7	70	95	10	460	500	20		
	47			95			480		520	
	52			100			480		520	
	45			100			500		540	
	47			110						
32	45	8	80	110	10					
	47			110						
	52			120						
	45			120						
	47			120						



Headoffice

ERIKS bv
Toermalijnstraat 5
1812 RL Alkmaar
Tel. +31 72 514 15 14
Fax +31 72 515 56 45
info@eriks.nl

ERIKS Servicecenters

Alkmaar

Saffierstraat 3
NL-1812 RM Alkmaar
T +31 72 514 17 17
F +31 72 514 16 25
esc.alkmaar@eriks.nl

Almelo

Plesmanweg 12
NL-7602 PE Almelo
T +31 546 87 30 70
F +31 546 87 32 68
almelo@eriks.nl

Amsterdam

Dynamostraat 46-48
NL-1014 BK Amsterdam-Westpoort
T +31 20 448 96 10
F +31 20 613 77 65
amsterdam@eriks.nl

Arnhem

Pieter Calandweg 46
NL-6827 BK Arnhem
T +31 26 362 92 44
F +31 26 361 00 63
arnhem@eriks.nl

Den Haag

Neckar 2
NL-2491 BD Den Haag
T +31 70 381 84 84
F +31 70 381 84 36
denhaag@eriks.nl

Eindhoven

De Witbogt 22
NL-5652 AG Eindhoven
T +31 40 291 19 00
F +31 40 291 19 09
eindhoven@eriks.nl

Hengelo

Hassinkweg 16
NL-7556 BV Hengelo
T +31 74 291 57 57
F +31 74 291 59 39
hengelo@eriks.nl

Leek

Zernikelaan 10
NL-9351 VA Leek
T +31 594 51 70 00
F +31 594 51 41 93
leek@eriks.nl

Leeuwarden

James Wattstraat 18
NL-8912 AS Leeuwarden
T +31 58 215 05 87
F +31 58 215 85 16
leeuwarden@eriks.nl

Maastricht

Amerikalaan 28
NL-6199 AE Maastricht-Airport
T +31 43 604 91 80
F +31 43 363 87 28
maastricht@eriks.nl

Roermond

Ada Byronweg 11
NL-6045 GM Roermond
T +31 475 37 22 70
F +31 475 37 23 05
roermond@eriks.nl

Rotterdam

Cairostraat 80
NL-3047 BC Rotterdam
T +31 10 245 50 55
F +31 10 262 00 38
rotterdam@eriks.nl

Rotterdam-Botlek

Shannonweg 33, Haven 5079
NL-3197 LG Botlek-Rotterdam
T +31 10 231 34 00
F +31 10 296 73 97
eriks.rijnmond@eriks.nl

Tilburg

Ellen Pankhurststraat 9
NL-5032 MD Tilburg
T +31 13 571 45 61
F +31 13 570 06 42
tilburg@eriks.nl

Zwolle

Amperestraat 27
NL-8013 PT Zwolle
T +31 38 467 29 20
F +31 38 467 29 29
zwolle@eriks.nl

ERIKS

know-how makes the difference



ERIKS bv
PO Box 280
NL-1800 BK Alkmaar

T +31 72 514 15 14
info@eriks.nl
www.eriks.nl